

Article number: 3213331

Description: Ortlinghaus Coupling size 31

Measures

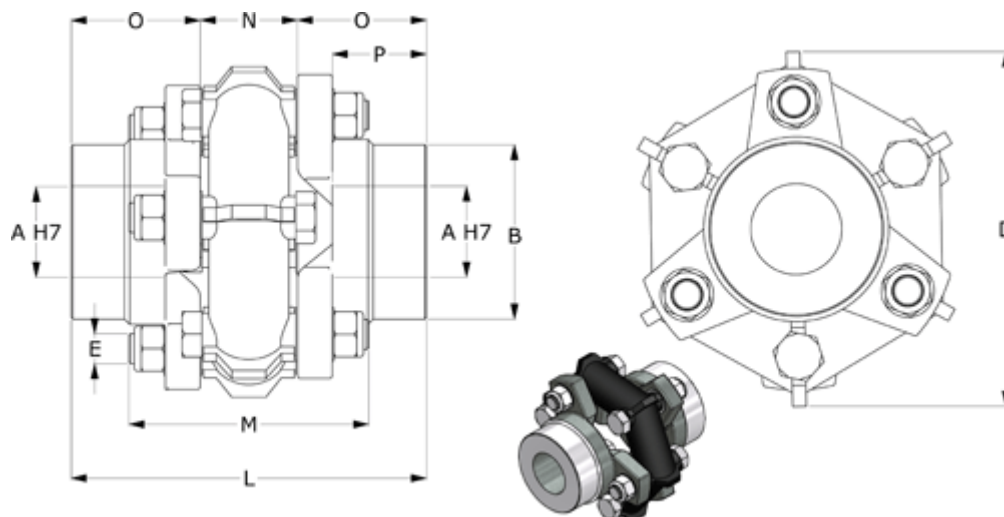

A max H7	= 48	M	= 104	Tightening torque N m	= 78
Axial displacement mm	= +/-4	Moment of inertia kg/m ²	= 0.00300	Weight	= 3.5
B	= 72	N	= 46		
Bending angle	= +/-2,8	O	= 57		
C	= 100	P	= 48		
D	= 142	Radial displacement	= +/-0,6		
E	= M12	Standard running NM	= 160		
L	= 160	Stress load Nm	= 400		